

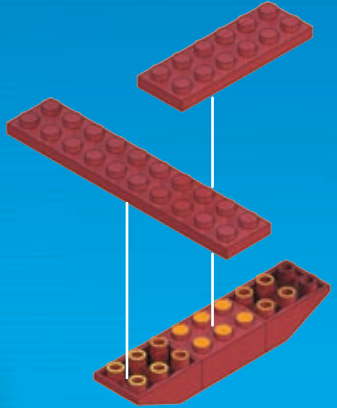

1

2x 1x

1x 1x



2

2x 2x

2x 2x 2x

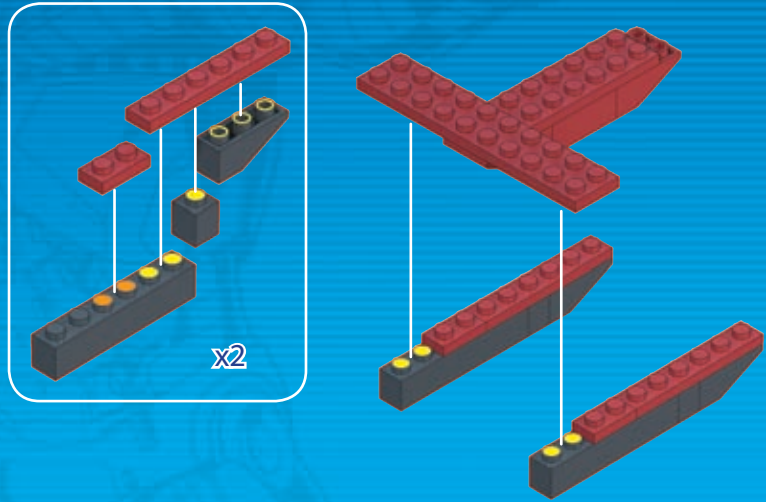

3

2x

1x 1x

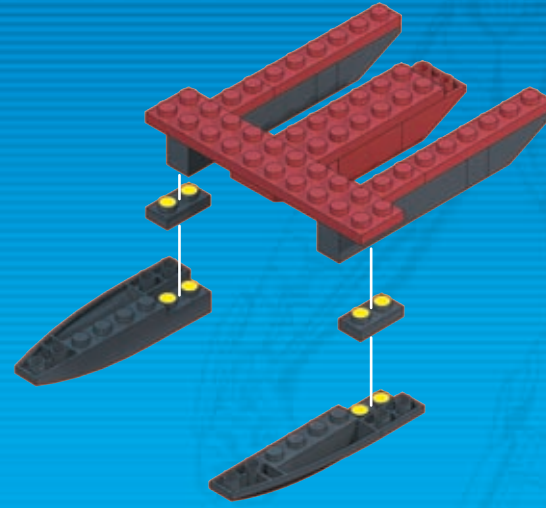

4

2x

2x

1x

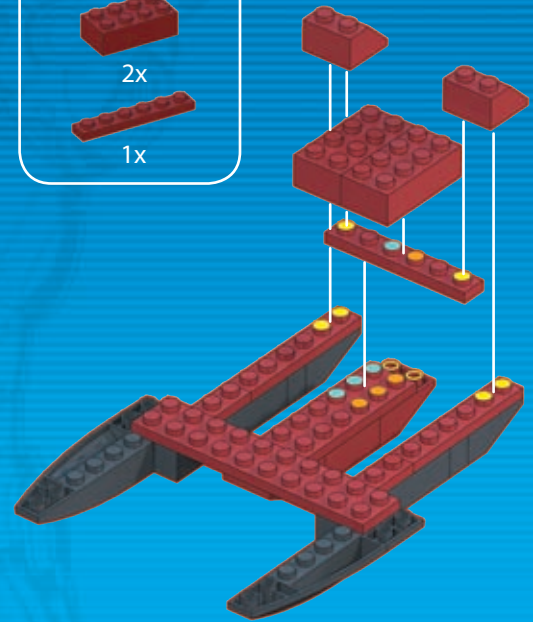

5

1x

1x 2x

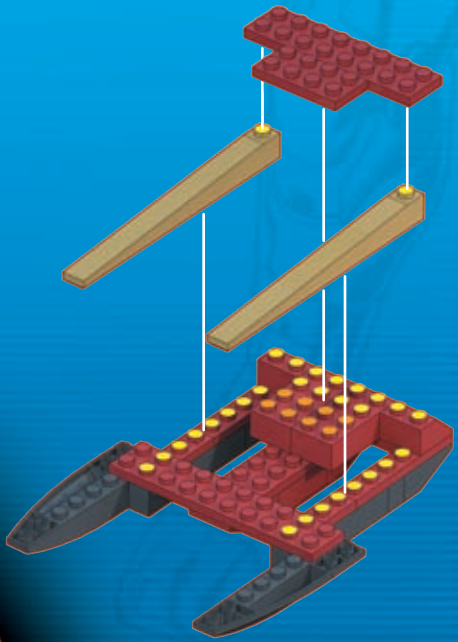

6

4x 2x 2x 2x 1x

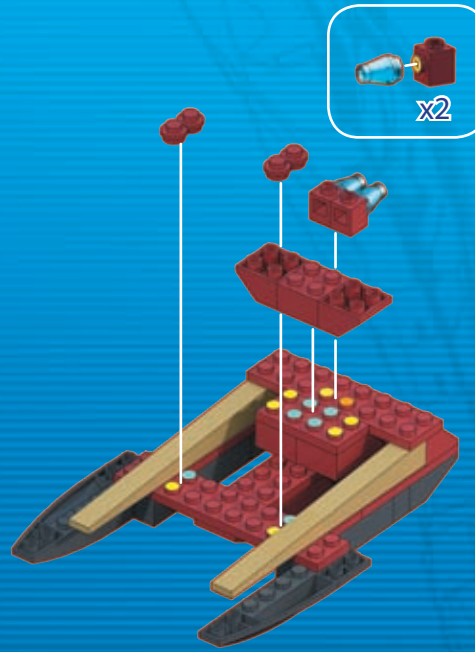

x2

7

1x 1x

1x 4x 1x 1x

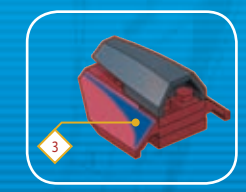
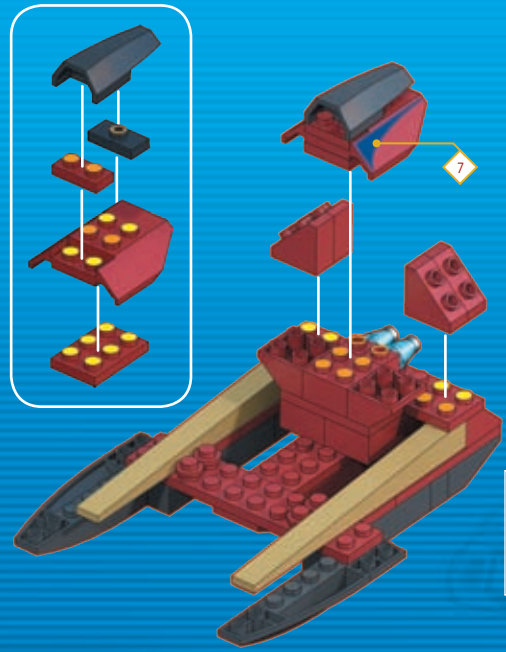

Choose best place for stickers! | ¡Elige el mejor lugar para las pegatinas! | Choisissez le meilleur endroit pour les autocollants! | Klebe die Aufkleber auf eine beliebige Stelle! | Kies de beste plaats voor de plakplaatjes! | Autoadesivi da mettere dove vuoi tu! |

8

1x 1x 1x

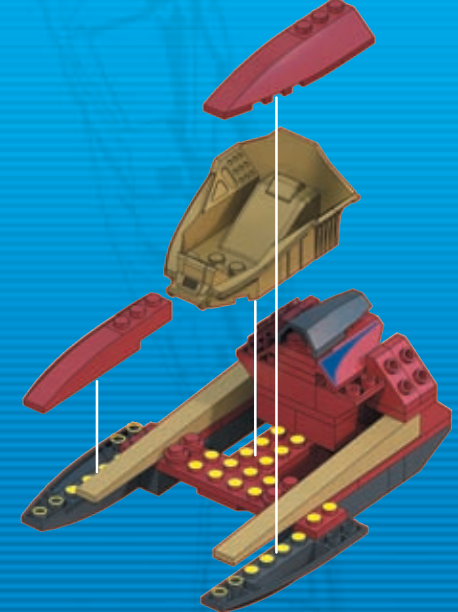

Collect them all! - ¡Coleccionalos todos! -  
Collectionne-les tous! - Sammle alle! -  
Verzamel ze allemaal! - Collezionali tutti! -  
Colecciona todo

Build & Rebuild!  
¡Crea & vuelve a crear!  
Construis et reconstruis!  
Bau und Neubaui  
Bouwen en herbouwen!  
Costruisci e ricostruisci!  
Construie Reconstruie!



9

4x 2x 2x

10

4x 2x 1x 1x

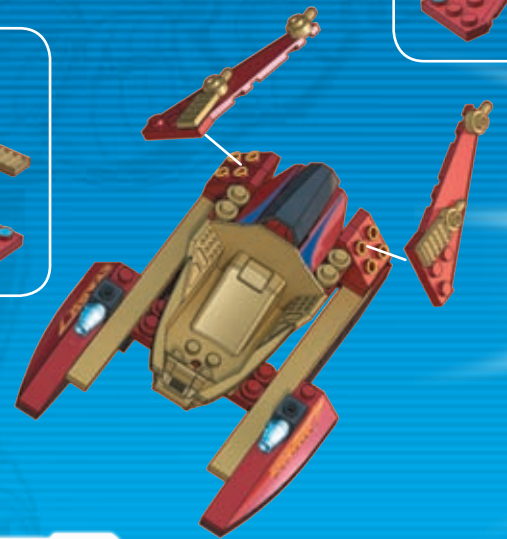
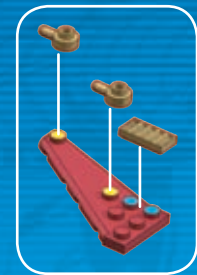
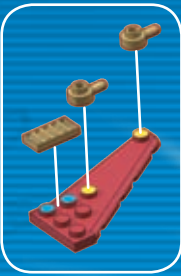

11

1x 1x 1x

1x

1x



12



4x AM01113AKM	4x AM01113AKM	4x AM01312AKL	4x AM08412AJAM0910WH	1x MA1086KM	2x AM09393AKM	3x AM07590KM	2x AM09198AKL	2x AM09393KM	2x AM07629KM	2x AM07629AKM
2x MA1154AKM	2x MA10273AKM	1x MA1404BMG	2x MA1418KM	4x AM04218AKM	1x AM09023AKM	2x MA1139AKM	1x AM03873AKM	2x AM09033AKM	1x AM08416KM	
1x AM03772AKM	1x AM09493AKM	1x AM01480AKM	3x AM09292AKM	1x AM08483AKM	1x AM09923AKM	2x AM01313KM				
1x AM15512BMG	1x AM08409AKM	1x MA1176E	1x MA1137E	1x AM09185AKM	1x AM09184AKM	1x AS0195501	1x AL019551			
1x AM09187KM	1x AM09186KM	1x AM16659AKM	1x AM16654AKM	2x AM15510AKL	1x AM17089AKL					

EN Please read these instructions carefully before first use and keep them for future reference. / ES Leer estas instrucciones cuidadosamente antes de la primera utilización y guardarlas para referencia futura. / FR Il est recommandé de lire attentivement ce feuillet avant la première utilisation et de le conserver pour référence future. / DE Die Gebrauchsanleitung bitte durchlesen und aufbewahren. / NL Wij raden u aan deze handleiding zorgvuldig te lezen en te bewaren voor eventuele raadpleging op een later tijdstip. / PT Leia as instruções antes do primeiro uso e guarde-as para futura referência. / IT Leggere le istruzioni prima di cominciare ad usare il gioco e conservarle per referenze future.

EN ⚠ WARNING: CHOKING HAZARD. - Small parts. Not for children under 3 years.

ES ⚠ ADVERTENCIA: PELIGRO DE ASFIXIA. - Contiene piezas pequeñas. No recomendado para niños menores de 3 años.

FR ⚠ AVERTISSEMENT: RISQUE DE SUFFOCATION. - Présence de petits éléments. Ne convient pas aux enfants de moins de 3 ans.

DE ⚠ WARNUNG: ERSTICKUNGSGEFAHR. - Enthält kleine Teile. Nicht für Kinder unter 3 Jahren geeignet.

NL ⚠ WAARSCHUWING: VERSTIKKINGSGEVAAR. - Bevat kleine onderdelen. Niet geschikt voor kinderen onder de 3 jaar.

DA ⚠ ADVARSEL: KVELNINGSFARE. - Indeholder smådele. Ikke til børn under 3 år.

EL ⚠ ΠΡΟΕΙΔΟΠΟΙΗΣΗ: ΚΙΝΔΥΝΟΣ ΠΝΙΞΙΜΑΤΟΣ. - Περιέχει μικρά αντικείμενα. Όχι για παιδιά κάτω των 3 ετών.

FI ⚠ VAROITUS: TUKEHTUMISVAARA. - Sisältää pieniä osia. Ei alle 3-vuotiaille lapsille.

IT ⚠ ATTENZIONE: PERICOLO DI SOFFOCAMENTO. - Contiene piccole parti. Non indicato per bambini sotto i 3 anni.

NO ⚠ ADVARSEL: KVELNINGSFARE. - Inneholder små deler. Kun for barn over 3 år.

PT ⚠ ATENÇÃO: PERIGO DE ASFIXIA. - Contém peças pequenas. Não é concebido para crianças de menos de 3 anos.

SV ⚠ VARNING: KVÄVNINGSRISK. - Innehåller små delar. Inte för barn under 3 år.

JA ⚠ 警告: 窒息の危険性 - 小さな部品が含まれています。3歳以下の子供には与えないで下さい。

ZH ⚠ 警告: 窒息危险 - 包含有小部件。不适合3岁以下的儿童玩。

AR ⚠ تحذير: خطر اختناق - قطع صغيرة. غير صالحة للأطفال أقل من 3 سنوات.



© 2010, MEGA Brands Inc. MEGA Brands Inc. and the MEGA Brands Inc. logo are registered trademarks of MEGA Brands Inc. MEGA Brands Inc. y el logotipo MEGA Brands Inc. son marcas registradas de MEGA Brands Inc. MEGA Brands Inc. et le logo de MEGA Brands Inc. sont des marques de commerce déposées de MEGA Brands Inc. MEGA Brands Inc. und das MEGA Brands Inc.-Logo sind eingetragene Warenzeichen von MEGA Brands Inc. MEGA Brands Inc. en het MEGA Brands Inc. logo zijn gedeponeerde handelsmerken van MEGA Brands Inc. MEGA Brands Inc. ed il logo di MEGA Brands Inc. sono marchi di fabbrica di MEGA Brands Inc. MEGA Brands Inc. e o logo MEGA Brands Inc. são marcas registradas de MEGA Brands Inc.

Printed in China

AD019551A

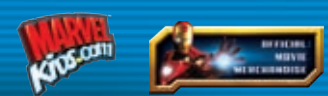

Marvel Studios' IRON MAN 2, the Movie © 2010 MVL Film Finance LLC. Marvel, Iron Man, all related character names and their distinctive likenesses: TM & © 2010 Marvel Entertainment, Inc. and its subsidiaries. All rights reserved.

# ADDENDUM

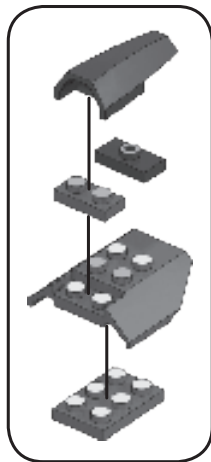
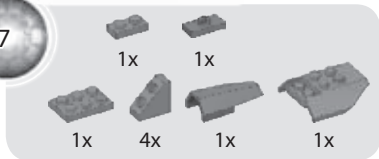

© 2010, MEGA Brands Inc.

MEGA Brands Inc. and the MEGA Brands Inc. logo are registered trademarks of MEGA Brands Inc.

MEGA Brands Inc. y el logotipo MEGA Brands Inc. son marcas registradas de MEGA Brands Inc.

MEGA Brands Inc. et le logo de MEGA Brands Inc. sont des marques de commerce déposées de MEGA Brands Inc.

MEGA Brands Inc. und das MEGA Brands Inc.-Logo sind eingetragene Warenzeichen von MEGA Brands Inc.

MEGA Brands Inc. en het MEGA Brands Inc. logo zijn gedeponeerde handelsmerken van MEGA Brands Inc.

MEGA Brands Inc. ed il logo di MEGA Brands Inc. sono marchi di fabbrica di MEGA Brands Inc.

MEGA Brands Inc. e o logo MEGA Brands Inc. são marcas registradas de MEGA Brands Inc.

Printed in China

AD019552

